



Image for demonstration purposes

Generating Set
SUPERSILENT - Diesel

GE.BD.022/020.SS+011

1500 rpm - Threephase - 50Hz - 400V
 Multifunction panel without switching on board



Standard equipment

Canopy Soundproofing

Removable soundproof canopy
 Painting canopy (RAL) in galvanized sheet steel
 Soundproofing with class 1 polyester material
 Handles with key lock and automatic closing
 Special baffles for air intake and air expulsion
 Inspection doors for controls and maintenance

Exhaust

Exhaust rain cap
 Insulated exhaust pipes
 Internal residential muffler - 35dB(A)

Fuel Supply

Single wall daily tank with bunded base
 Automatic shutdown system for low fuel level
 Fuel gauge

Handling

Lifting hook integrated into the bearing structure
 Base frame with anti-overturning forklift pockets
 Reinforced base frame and crossbar for mobile use
 forkliftable on the short side

Base Frame

Bunded base at 110% of fuel tank capacity
 Anti-vibrating mounting pads
 Battery compartment externally accessible for easy service

Engine

High coolant temperature and low oil pressure shutdown system
 External oil drain points
 Engine liquids (oil and antifreeze)
 Tropicalized radiator
 Rotating parts protection
 Electronic speed governor

Alternator

AVR Automatic Voltage Regulator
 Impregnation for marine environment
 IP23

Panel & connection

Emergency Stop button
 Protection by controller
 Tamperproof panel IP55
 Cable output from the bottom
 IP44 wiring
 Start-up battery (pre-charged)
 Grounding point

Documentation

CE conformity declaration
 User and Maintenance manual
 Wirings diagrams

Normatives

All Generating sets are compliant to CE Marking
 2014/30/UE Electromagnetic compatibility
 2000/14/CE Noise Emission for outdoor use
 Factory-designed systems built according to ISO 9001:2015
 CEI EN 60204-1:2018 - Electrical equipment of machines

Primary data

General Information

Speed	RPM	1500
Frequency	Hz	50
PRP	KVA	20
PRP - Prime power	KW	16,0
LTP - Standby power	KVA	21
LTP - Standby power	KW	16,8
Standard Voltage	V	400/230
Current	A	28,9
Voltage for current calculation	V	400
COSFI	0,8	0,8

General electrical protection

Circuit-breaker rated current	A	32
Type		Magnetothermal switch on panel board
Circuit-breaker poles	N	4P
Optional/notes circuit-breaker		Opening coil

Noise level +/- 3dB(A)

LWA	dB(A)	85
Sound pressure level @ 7 mt	dB(A)	60
Sound pressure level @ 1 mt	dB(A)	69

Fuel Consumption

TYPE		Diesel
Standard Fuel Tank capacity	lt	110
Autonomy @ 75% load	h	25
Fuel consumption at 100% load	lt/h	6,2
Fuel consumption at 75% load	lt/h	4,5
Fuel consumption at 50% load	lt/h	3,2

General data

Rated capacity	Ah	1x70
Auxiliary Voltage	V	12
Exhaust gas flow	l/s	86
Combustion air flow	l/s	23
Cooling fan airflow	mc/s	0,8
Exhaust diameter	mm	50

Weight and Dimensions

Dimensions (L x w x h)	cm	175x90x140
Weight with liquids (excluding optionals and fuel)	Kg (+/-3%)	782

Engine

Factory		Baudouin
Model		4M06G25/5
Emissions stage		Stage 0
Speed governor		Electronic
Radiator	°C	50
Cooling	Tipo	liquid (water + 50% Paraflu11)
Active net power	Kwm	21,7
Nominal net power	CV	29,5
Cycle	Tipo	4 strokes
Aspiration	Tipo	Natural
Numbers of cylinders	N	4
Cylinders arrangement		L
Bore	mm	89
Stroke	mm	92
Total displacement	lt	2,288
Engine oil features		15W40-API CI-4/CH-4 ACEA E5-E7
Total oil capacity	lt	12
Total coolant capacity	lt	16
ISO 8528-5 class		G2

Alternator

*** May vary based on stock availability. However, a primary brand will be used.**

Factory		Stamford
Model		S0L2-G1
Single-phase Range	KVA	20
Voltage Regulator (voltage accuracy)	+/- %	1
Poles	N°	4
Phases	N°	3+N
Standard windings connection		Star Series
Stator/rotor impregnation		H (Outdoor Temp 40°C)
Efficiency	%	86,8
Engine coupling		Elastic disk
Short circuit current		>= 300% (3In)
Protection degree	IP	23
Cooling system		Self ventilating
Maxium overspeed	rpm	2250
Waveform distortion	%	<5
Exciter		Diode bridge

Standard operating environmental conditions

Ambient temperature	°C	25
Relative Humidity	%	30
Max altitude	mt	1000

Control Systems on board QLE-B-SC-3F-4P-63-01



operating scheme - schema di funzionamento

QLE Multifunction panel without switching on board

The QLE command and control panel offers outstanding protection, monitoring and control for small and middle size generator sets. Elcos's control module MC2 Plus offers advanced features to meet the most demanding on-site application. Elcos's control module MC2 Plus is designed to offer an easy user interface. Variant without transfer switch. The panel directly manages the QLTS and QC panels. The output line is protected by a magnetothermic breaker with opening coil. The overload and short-circuit protection is managed by the control board.

Mechanical features

Protection degree	IP	55
-------------------	----	----

Battery charger

Model		ELCOS - CB1
Maximum output current	A	2,5
Output DC voltage (selectable)	V _{dc}	12-24
Input AC voltage (selectable)	V _{ac}	220-260
Frequency	Hz	50-60

Data Communication

Data connection port		RS-485
Communication protocol		Mod-bus RTU-8N1

Remotable functions in terminal box

GS start	Genset contactor close/open command (1)
Mains contactor close/open command (2)	Remote horn - DC output
Programmable output - Volt free output	

(1) Ready to load function (ARS mode without QC or QLTS panel)(1) Genset contactor open and close command (AMF mode with QC or QLTS panel)(2) Mains contactor open and close command (AMF mode with QC or QLTS panel)

Control Module



Model	MC2 Plus
Operating mode	AMF - ARS

Specifics

Applications

Emergency to the Mains
Stand-alone
Construction site/Rental
Self-production

ENGINE MEASURES

Fuel tank level %
Engine oil pressure BAR (1)
Engine Coolant temperature °C (1)
Total run time
Battery voltage
Start-ups counter
Engine speed

ALTERNATOR MEASURES

Generator Voltage L1, L2, L3
Generator Voltage L1-N, L2-N, L3-N
Generator frequency
Generator current L1, L2, L3
Generator Apparent Power kVA
Generator Active Power kW

COMMUNICATION PORTS

Can-bus port
RS485 port with Mod-bus RTU communication
USB port for parameters saving and firmware update

EQUIPMENT

Microprocessor Logic
Back-lit display
Programmable from display
16 event log
Icons management
STOP button
START button
TEST button
Reset alarm button
Alarm mute button

PRE-ALARMS/ ALARMS

Common Alarm
Fuel reserve (pre-alarm)
Low fuel level (alarm)
Charge alternator failed (dinamo)
Low oil pressure (alarm)
Oil sensor failed (alarm)
High coolant temperature (alarm)
Low water level (1)
Water in fuel (1)
Battery undervoltage
Battery overvoltage
GS failure to start
GS failure to stop
Can-bus Failure
No Can-bus communication
Genset overload L1, L2, L3 phases
Genset short circuit
Genset overvoltage
Genset undervoltage
Genset high frequency
Genset low frequency
overspeed
Earth fault (alarm)
Maintenance request
Emergency button pressed
Remote emergency active
Genset negative phase sequence

VISUALIZATIONS ON CONTROL

MODULE/DISPLAY

Pre-alarms
Alarms
Engine measures
Alternator measures
Operating mode
Genset status
Genset contactor status
Glow plugs status

CONTROL MODULE FUNCTIONS

Remote Start and Stop
Manual Start and stop
Emergency stop button on panel board
Remote emergency stop
Remote test on load
Scheduled start-ups
MODBUS commands (Start, Stop, Reset, Test)

Elcos MC2 control module is designed for diesel generating sets. It offers outstanding protection, monitoring and control for small and middle size generator sets.

AAABBB

OPTIONAL

⚙️ Fuel Supply

**O.G-ACO-AT-C3V-01**

External fuel tank connections with 3-way valve for supply from internal or external tank (10/100 kVA)

**O.G-ACO-AT-C3V-AR-01**

Quick coupling connectors with 3-way valve for internal or external fuel tank connection (10/100 kVA)

**O.G-ACO-AT-CI-01**

External tank connections for supply only from external tank (g without tank) GE 10/100

**O.G-ACO-BT-C1750-600**

600 Lt Oversized Fuel Tank on board for SS,RB (10/20 kVA)

**O.G-ACO-GA-01**

Mechanical analogue float for internal fuel tank on board

**O.G-ACO-GA-02**

Electrical analogue float to monitor the external refilling point on board

**O.G-ACO-RE-01**

External refilling point for Gen Sets 10/250 kVA, SS, RB versions

**O.G-ACO-RE-SP-01**

External refilling point with warning light for Gen Sets 10/250 kVA, SS, RB versions

⚙️ Alternator

O.G-ALT-AL-CHBR-01

Different brand alternator (10/40 kVA)

⚙️ Batteries

**O.G-BAT-BAE-01**

Maintenance free high efficiency starter batteries (10/40 kVA)

**O.G-BAT-STB-01**

Battery isolator lockable (10/100 kVA)

⚙️ Canopy

**O.G-COF-AM-01**

Hinges and Doors with tamper-proof device (10/100 kVA)

**O.G-COF-AP-01**









Door opening alarm system (each door)

O.G-COF-C1750-INOX





Additional cost for stainless steel canopy (C1750)















**O.G-COF-CA-C1750**

IP 43 Conveyors for Gen Sets 10/20 kVA - supplied disassembled

	O.G-COF-CH-01	Additional cost for larger canopy C1900 instead of standard C1750 - Dim. cm 190x90x150H - Fuel tank 110 lt
	O.G-COF-DLO-C1750-05KW	Dummy Load 5kW on board for Gen Sets 20 kVA
	O.G-COF-EAF-01	Frontal air expulsion for Gen Sets 10/20 kVA (C1750) (change the noise level)
	O.G-COF-FP-01	Door stop (10/100 kVA)
	O.G-COF-IL-01	Internal LED lighting with micro-switches for Gen Sets 10/250 kVA
	O.G-COF-PV-01	Lift off doors kit (10/100 kVA) for SS and PRO version
	O.G-COF-TRT-MAR-01	High resistance canopy treatment for corrosive environments for 10/40 kVA (SS, RB Versions)
	O.G-COF-VER-PAR-01	Canopy custom paint (Grey base-frame) for 10/40 kVA (SS, RB Versions)
	O.G-COF-VER-TOT-01	Total canopy custom paint for 10/40 kVA (SS, RB Versions)

⚙️ Electrical on board

	O.G-USP-MO-01	Terminal box with tightening terminals inside the cable entry compartment for Gen Sets 10/40 kVA SS Version
	O.G-USP-SW-MOT.0010-0040	Motorization switch on board machine, integrated in the panel for 10/40 Kva Ge - (for variant +11)
	O.Q-QBM-BMIN-230V-01	Additional price for 230V minimum voltage coil on the modular main switch inside the control panel (check feasibility)
	O.Q-QBM-CPI-BEN-01	Permanent insulation controller for IT networks up to 230V / 400V. BENDER IR423-D4-1. Adjustable threshold 10 ÷ 300 kohm. (2 DIN rail modules - check feasibility)
	O.Q-QLE-K-DIF-M3	Adjustable differential protection only for MC2-PLUS controller for Gen Sets 10/500 kVA (+011 variant)
	O.Q-QLE-QBM-COM-AMF25	Additional price for QBM COMAP AMF25 panel replacing the standard QLE-A.
	O.Q-QLE-QBM-DSE-7320	Additional price for QBM DSE7320 panel replacing the standard QLE-A.
	O.Q-QLE-QPE-MC4	Additional price for QPE-C panel with MC4 replacing the standard QLE-A.

	O.Q-QMC-K-DIF-R1	Adjustable differential protection only for QMC panel for Gen Sets 10/40 kVA (Variant +010 / +011)
	O.Q-QMC-RX8-QMC	Start-stop radio control with max. radius 500 mt indoors and 5 km outdoors (for QMC panel).
	O.Q-QMC-SAS-01	Auto Start-Stop at load request (QMC panel)
	O.Q-QPE-INT-CST-01	GE main switch STATUS contact wired to terminal board inside the QPE panel on board generator (10 / 40KVA) (no variant +10)
	O.Q-QPE-SAS-02	Auto Start-Stop at load request (QPE, QLE panels)
Engine		
	O.G-MOT-FC-1	Dust collector filter - for Gen Sets 10/20 kVA
	O.G-MOT-FSA-1	Fuel/Water Separator Filter - for Gen Sets 10/20 kVA
	O.G-MOT-K-40C-01	Engine liquids suitable for -40°C ambient temperature for Gen Sets 10/40 kVA
	O.G-MOT-PO-01	Oil change pump for Gen Sets 10/100 kVA
	O.G-MOT-RF-01	Electronic speed governor for Gen Sets 10/40 kVA
	O.G-MOT-SC-AC-EL-01	Engine pre-heater 230V with thermostat on board for Gen Sets 10/100 kVA + 130/500 PRO version
	O.G-MOT-SC-AC-EL-02	Super hot engine heater 230V with thermostat on board for Gen Sets 10/100 kVA
	O.G-MOT-SE-PO-LR	Oil pressure level and engine temperature sensors (from 10 to 100kVA)
	O.G-MOT-SRO-AU-12L	Automatic oil refilling system (10/40 kVA)
Handling		
	O.G-MOV-CN-3	Off-road trailer with 2 pneumatic wheels and tow bar (SS, RB Gen Sets 10/40 kVA)
	O.G-MOV-CO-ST-02	Roadworthy trailer 80km/h (10/40 kVA), registration excluded.

O.G-MOV-GC-BIG-01

Increased central lifting hook with 10x5cm hole (10/250 kVA SS version)

O.G-MOV-KRM-SS-01

Reinforcement kit for mobile installation (dedicated trailers or wheeled machinery) SS
Version from 10 to 40 kVA

ATS Panels

QC1.0060A

Separate ATS panel, 4P - 60A contactors (40 kVA 400V - 30 kVA 230V) Dim. 60 x 25 x 80 cm - 47 kg. (ex QC1.040)

QLTS.060A

Wall-mounted ATS switching panel 60A 4P (40 kVA 400V - 20 kVA 230V) Dim. 40 x 16 x 40 cm - 12 kg.

Exhaust

O.G-SCA-CAT-02

Catalytic converter (20 kVA)

O.G-SCA-FAP-K20

Particulate filter (DPF) for Gen Sets 10/20 kVA

O.G-SCA-GF-50

Exhaust bellow with flexible joint including flange and counter flange (10/40 kVA)

O.G-SCA-KS-50

Exhaust flex pipe for drainage (length 3 mt.)

O.G-SCA-PF-01

Spark arrester for Gen Sets 10/40 kVA

O.G-SCA-PR-01

Exhaust pipe protection kit (10/20 kVA) , SS,RB version

Test

MS.CP-LT-01

FAT - Factory Acceptance Test for single Gen Set from 10 to 100 kVA according to our standard procedures in Elcos factory (max 2 hours - max 4 people - max 1 hour of operation)

MS.CP-SP-01

FAT - Factory Acceptance Test for single custom Gen Set from 10 to 100 kVA max 4 operating hours or parallel system up to 4 units for 1 operating hour, in Elcos factory (max 4 hours - max 4 people)

MS.CP-ST-01

FAT - Factory Acceptance Test for single Gen Set from 10 to 100 kVA according to our standard procedures in Elcos factory (max 4 hours - max 4 people - max 2 hour of operation)

MS.RF-ST-01

Noise test report for single Gen Set from 10 to 250 kVA

MS.TV-ST-01

Vibration test on 10 points with certificate for single Gen Set from 10 to 250 kVA

Vari

O.G-VAR-CAT-01

Toolbox for ordinary maintenance.

O.G-VAR-PUN-TER-01

Round earth spike, diam. 20 mm, height 1.5mt, galvanized, complete with clamp and 3m yellow/green cable model FS17 1x35mm² with cable lugs.

O.G-VAR-PUN-TER-02

Cross-shaped earth spike, height 1.5mt, galvanized, complete with clamp and 3m yellow/green cable model FS17 1x35mm² with cable lugs.

O.G-VAR-TPD-01

IP 55 document holder

PRP

Engines of this rating provide unlimited hours of usage in a variable load application. The average load factor should not exceed 70% of the engine's prime power rating with a maximum number of 500 operational hours at 100% prime power rating. An overload capability of 10% is available, however, is limited to a period of 1 in every 12 hours

LTP

Limited-time running power is defined as the maximum power available, under the agreed operating conditions, for which the generating set is capable of delivering for up to 500h of operation per year with the maintenance intervals. The overload is not allowed.

Sheet:	C 1750	SUPER SILENT	Exhaust side:		Type:	STANDARD	Rev:	00	Last Update:	May 03, 2012	Page 1/2
--------	--------	--------------	---------------	--	-------	----------	------	----	--------------	--------------	----------

OVERALL DIMENSIONS [mm]

REAR VIEW

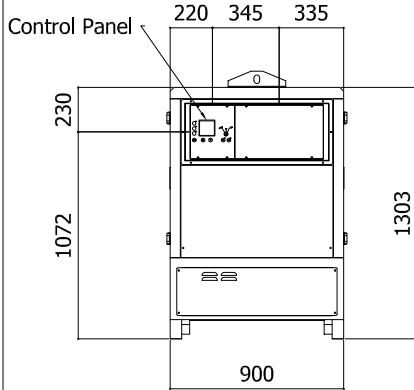

LEFT SIDE VIEW

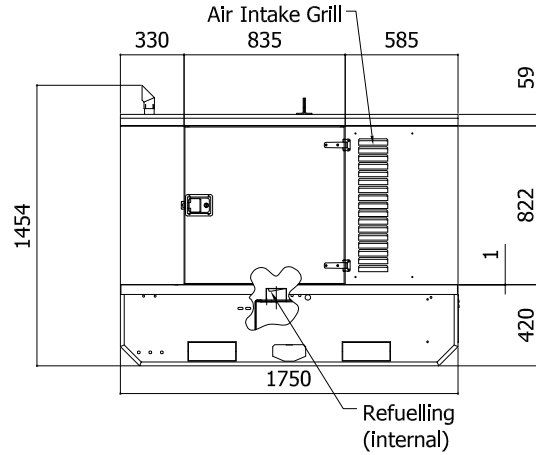

FRONT VIEW

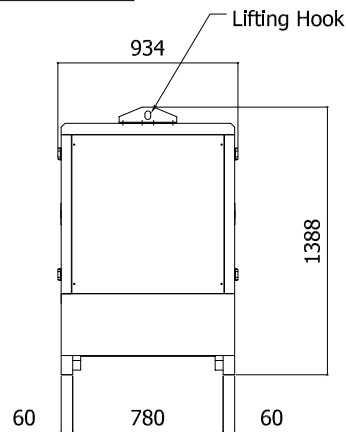

RIGHT SIDE VIEW

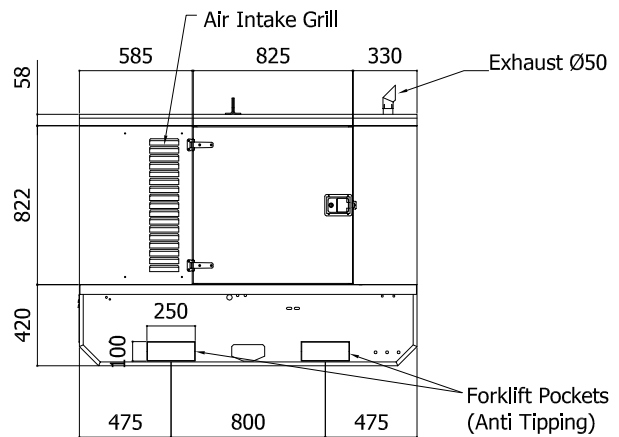

TOP VIEW

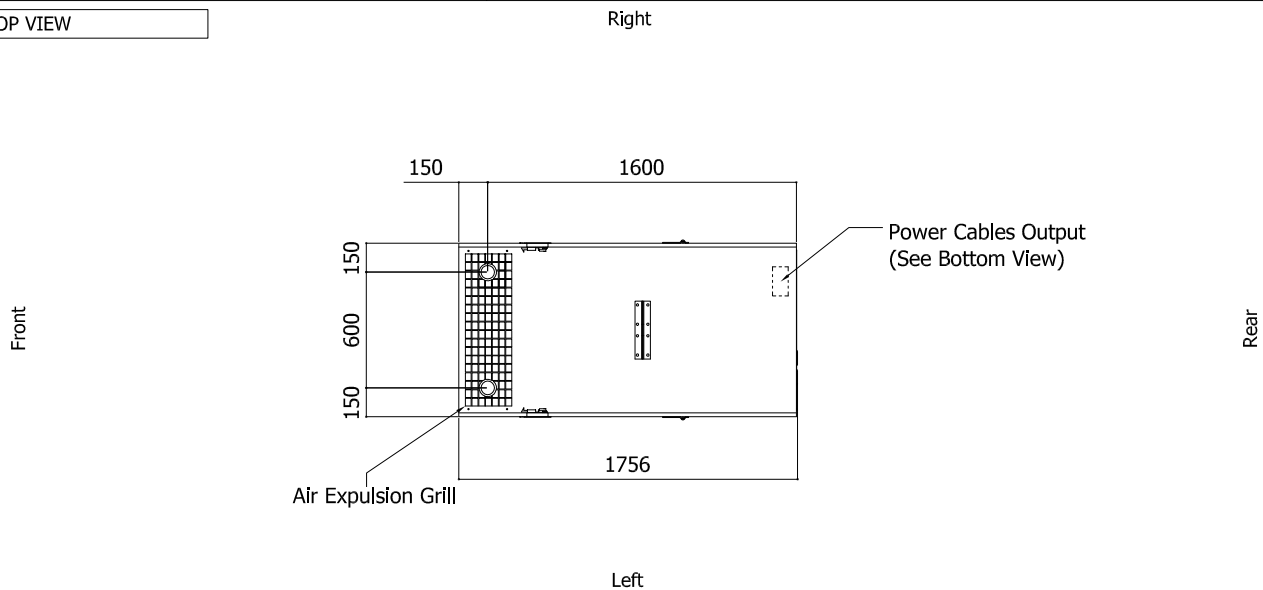

IMPORTANT:

- 1) Form and dimension refer to the generating set on catalogue
- 2) Form and dimension are subject to change in order to update or improve the products
- 3) This document can not be copied or transmitted without ELCOS S.r.l. approval

Sheet:	C 1750	SUPER SILENT	Exhaust side:		Type:	STANDARD	Rev:	00	Last Update:	May 03, 2012	Page 2/2
--------	--------	--------------	---------------	--	-------	----------	------	----	--------------	--------------	----------

BOTTOM VIEW

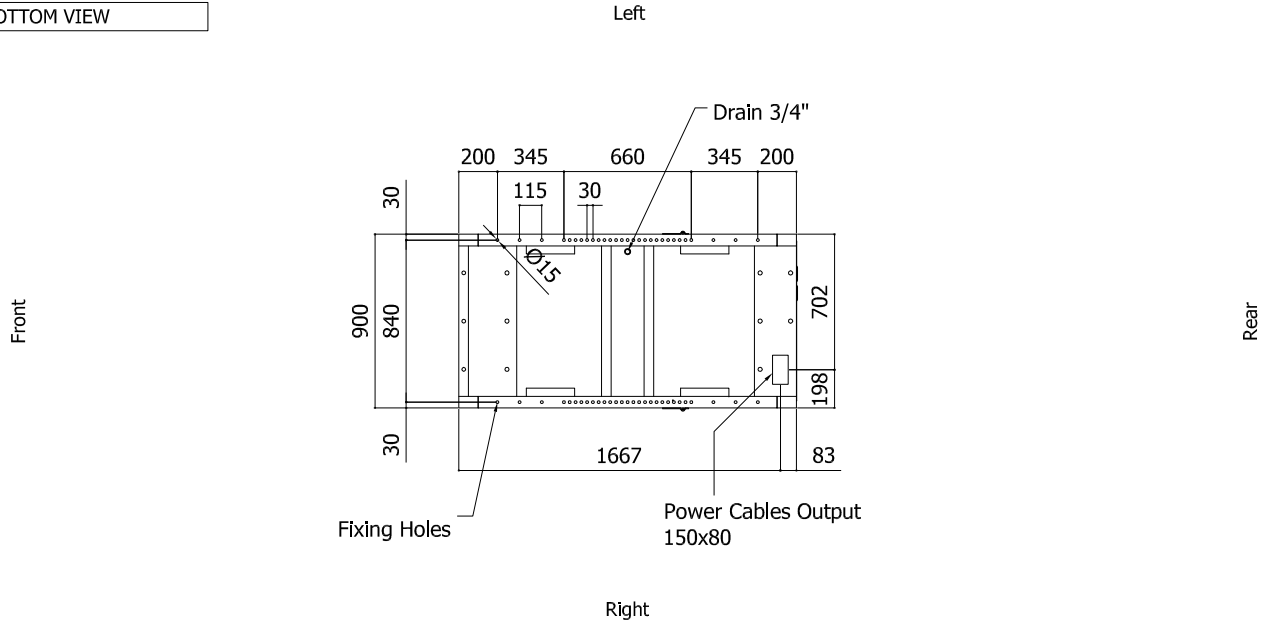

DIMENSIONS WITH OPEN DOORS [mm]

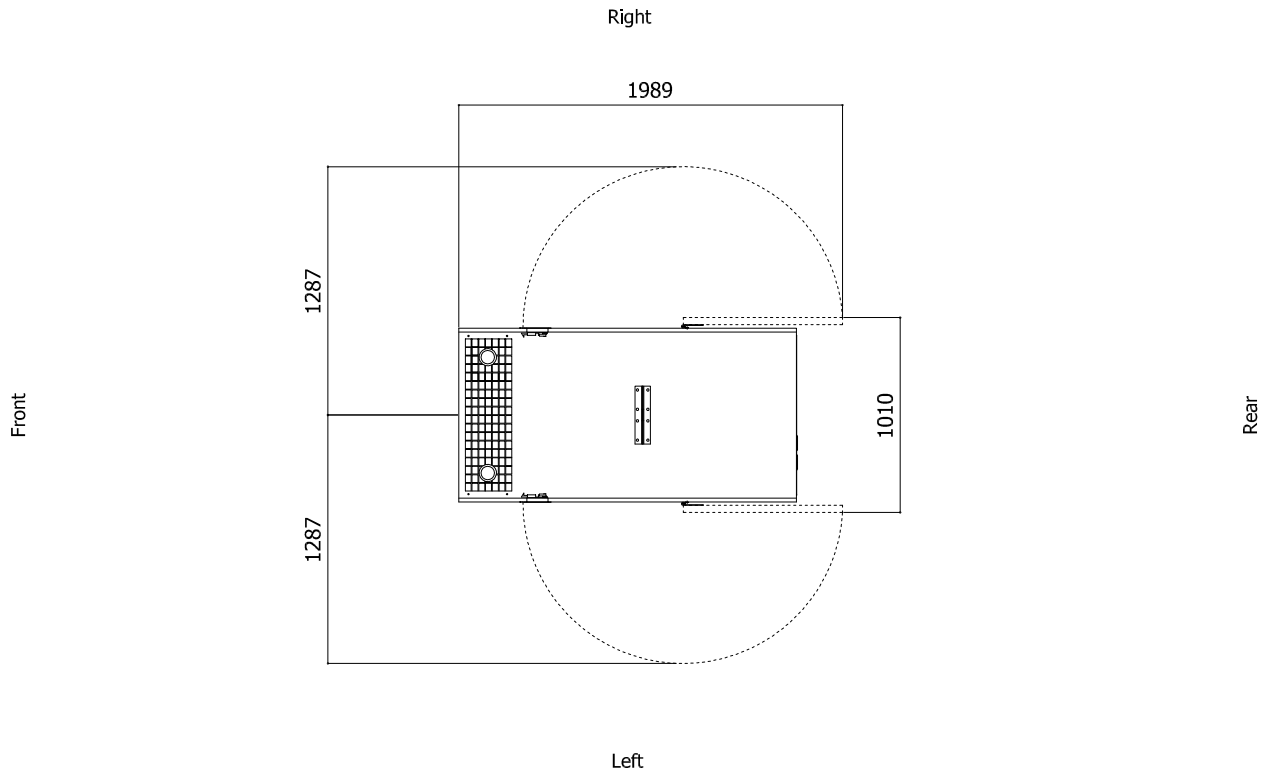

Note: With Lifting-Off Door Solution consider only canopy dimensions.
(Models with "Control Panel" behind rear door will mount a special cover to protect it)

VENTILATION OF THE ROOM

The windows area in the generating set room needs to be (recommended):
Aspiration: 0.26 m²
Expulsion: 0.21m²
ATTENTION: for a correct ventilation the expulsion air and the exhaust gas needs to be conveyed in the open-air

- IMPORTANT:**
- 1) Form and dimension refer to the generating set on catalogue
 - 2) Form and dimension are subject to change in order to update or improve the products
 - 3) This document can not be copied or trasmitted without ELCOS S.r.l. approval