



Image for demonstration purposes

 **Generating Set**  
**SUPERSILENT - Diesel**

**GE.PK.017/015.SS+111**

1500 rpm - Singlephase - 50Hz - 230V  
Multifunction panel without switching on board



## Standard equipment

### **Canopy Soundproofing**

Removable soundproof canopy  
Painting canopy (RAL) in galvanized sheet steel  
Soundproofing with class 1 polyester material  
Handles with key lock and automatic closing  
Special baffles for air intake and air expulsion  
Inspection doors for controls and maintenance

### **Exhaust**

Exhaust rain cap  
Insulated exhaust pipes  
Internal residential muffler - 35dB(A)

### **Fuel Supply**

Single wall daily tank with bunded base  
Automatic shutdown system for low fuel level  
Fuel gauge

### **Handling**

Lifting hook integrated into the bearing structure  
Base frame with anti-overturning forklift pockets  
Reinforced base frame and crossbar for mobile use  
forkliftable on the short side

### **Base Frame**

Bunded base at 110% of fuel tank capacity  
Anti-vibrating mounting pads  
Battery compartment externally accessible for easy service

### **Engine**

High coolant temperature and low oil pressure shutdown system  
External oil drain points  
Engine liquids (oil and antifreeze)  
Tropicalized radiator  
Rotating parts protection

### **Alternator**

AVR Automatic Voltage Regulator  
Impregnation for marine environment  
IP23

### **Panel & connection**

Emergency Stop button  
Protection by controller  
Tamperproof panel IP55  
Cable output from the bottom  
IP44 wiring  
Start-up battery (pre-charged)  
Grounding point

### **Documentation**

CE conformity declaration  
User and Maintenance manual  
Wirings diagrams

### **Normatives**

All Generating sets are compliant to CE Marking  
2014/30/UE Electromagnetic compatibility  
2000/14/CE Noise Emission for outdoor use  
Factory-designed systems built according to ISO 9001:2015  
CEI EN 60204-1:2018 - Electrical equipment of machines

## Primary data

### General Information

Speed	RPM	1500
Frequency	Hz	50
PRP	KVA	15
PRP - Prime power	KW	12,0
LTP - Standby power	KVA	17
LTP - Standby power	KW	13,6
Standard Voltage	V	230
Current	A	65,22
Voltage for current calculation	V	230
COSFI	0,8	0,8

### General electrical protection

Circuit-breaker rated current	A	63
Type		Sezionatore bordo quadro
Circuit-breaker poles	N	3P
Optional/notes circuit-breaker		Opening coil

### Noise level +/- 3dB(A)

LWA	dB(A)	83
Sound pressure level @ 7 mt	dB(A)	58
Sound pressure level @ 1 mt	dB(A)	67

### Fuel Consumption

TYPE		Diesel
Standard Fuel Tank capacity	lt	110
Autonomy @ 75% load	h	36
Fuel consumption at 100% load	lt/h	4,3
Fuel consumption at 75% load	lt/h	3,1
Fuel consumption at 50% load	lt/h	2,2

### General data

Rated capacity	Ah	1x70
Auxiliary Voltage	V	12
Exhaust gas temperature	°C	445
Exhaust gas flow	l/s	45
Combustion air flow	l/s	18,3
Cooling fan airflow	mc/s	0,4
Exhaust diameter	mm	50
Exhaust side		DX

### Weight and Dimensions

Dimensions (L x w x h)	cm	175x90x140
Weight with liquids (excluding optionals and fuel)	Kg (+/-3%)	702

## ⚙️ Engine

Factory		<b>Perkins</b>
Model		<b>403A-15G2</b>
Emissions stage		<b>Stage 0</b>
Speed governor		<b>Mechanic</b>
Radiator	°C	<b>50</b>
Cooling	Tipo	<b>liquid (water + 50% Paraflu11)</b>
Active net power	Kwm	<b>13</b>
Nominal net power	CV	<b>17,7</b>
Cycle	Tipo	<b>4 strokes</b>
Injection	Tipo	<b>Indirect</b>
Aspiration	Tipo	<b>Natural</b>
Numbers of cylinders	N	<b>3</b>
Cylinders arrangement		<b>L</b>
Bore	mm	<b>84</b>
Stroke	mm	<b>90</b>
Total displacement	lt	<b>1,496</b>
Engine oil features		<b>15W40-API CI-4/CH-4 ACEA E5-E7</b>
Total oil capacity	lt	<b>6</b>
Total coolant capacity	lt	<b>6</b>

## ⚙️ Alternator

\* May vary based on stock availability. However, a primary brand will be used.

Factory		<b>Stamford</b>
Model		<b>SOL2-M1</b>
Single-phase Range	KVA	<b>14,5</b>
Voltage Regulator (voltage accuracy)	+/- %	<b>1</b>
Poles	N°	<b>4</b>
Phases	N°	<b>1+N</b>
Standard windings connection		<b>Double delta</b>
Stator/rotor impregnation		<b>H (Outdoor Temp 40°C)</b>
Efficiency	%	<b>87,2</b>
Engine coupling		<b>Elastic disk</b>
Short circuit current		<b>&gt;= 300% (3In)</b>
Protection degree	IP	<b>23</b>
Cooling system		<b>Self ventilating</b>
Maxium overspeed	rpm	<b>2250</b>
Waveform distortion	%	<b>&lt;5</b>
Exciter		<b>Diode bridge</b>

## ⚙️ Standard operating environmental conditions

Ambient temperature	°C	<b>25</b>
Relative Humidity	%	<b>30</b>
Max altitude	mt	<b>1000</b>

# Control Systems on board QLE-B-SC-1F-3P-160-O1

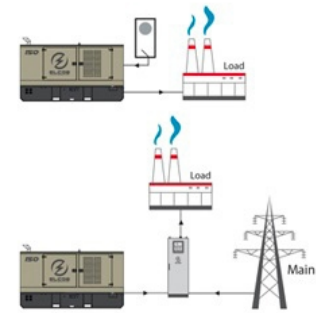

operating scheme - schema di funzionamento

## QLE Multifunction panel without switching on board

The QLE command and control panel offers outstanding protection, monitoring and control for small and middle size generator sets. Elcos's control module MC2 Plus offers advanced features to meet the most demanding on-site application. Elcos's control module MC2 Plus is designed to offer an easy user interface. Variant without transfer switch. The panel directly manages the QLTS and QC panels. The output line is protected by a switch disconnector with opening coil. The overload and short-circuit protection is managed by the control board.

### Mechanical features

Protection degree	IP	55
-------------------	----	----

### Battery charger

Model		ELCOS - CB1
Maximum output current	A	2,5
Output DC voltage (selectable)	V <sub>dc</sub>	12-24
Input AC voltage (selectable)	V <sub>ac</sub>	220-260
Frequency	Hz	50-60

### Data Communication

Data connection port		RS-485
Communication protocol		Mod-bus RTU-8N1

### Remotable functions in terminal box

GS start	Genset contactor close/open command (1)
Mains contactor close/open command (2)	Remote horn - DC output
Programmable output - Volt free output	

(1) Ready to load function (ARS mode without QC or QLTS panel)(1) Genset contactor open and close command (AMF mode with QC or QLTS panel)(2) Mains contactor open and close command (AMF mode with QC or QLTS panel)

## Control Module



Model	<b>MC2 Plus</b>
Operating mode	<b>AMF - ARS</b>

### Specifics

#### Applications

Emergency to the Mains  
Stand-alone  
Construction site/Rental  
Self-production

#### ENGINE MEASURES

Fuel tank level %  
Engine oil pressure BAR (1)  
Engine Coolant temperature °C (1)  
Total run time  
Battery voltage  
Start-ups counter  
Engine speed

#### ALTERNATOR MEASURES

Generator Voltage L1, L2, L3  
Generator Voltage L1-N, L2-N, L3-N  
Generator frequency  
Generator current L1, L2, L3  
Generator Apparent Power kVA  
Generator Active Power kW

#### COMMUNICATION PORTS

Can-bus port  
RS485 port with Mod-bus RTU communication  
USB port for parameters saving and firmware update

#### EQUIPMENT

Microprocessor Logic  
Back-lit display  
Programmable from display  
16 event log  
Icons management  
STOP button  
START button  
TEST button  
Reset alarm button  
Alarm mute button

#### PRE-ALARMS/ ALARMS

Common Alarm  
Fuel reserve (pre-alarm)  
Low fuel level (alarm)  
Charge alternator failed (dinamo)  
Low oil pressure (alarm)  
Oil sensor failed (alarm)  
High coolant temperature (alarm)  
Low water level (1)  
Water in fuel (1)  
Battery undervoltage  
Battery overvoltage  
GS failure to start  
GS failure to stop  
Can-bus Failure  
No Can-bus communication  
Genset overload L1, L2, L3 phases  
Genset short circuit  
Genset overvoltage  
Genset undervoltage  
Genset high frequency  
Genset low frequency  
overspeed  
Earth fault (alarm)  
Maintenance request  
Emergency button pressed  
Remote emergency active  
Genset negative phase sequence

#### VISUALIZATIONS ON CONTROL

##### MODULE/DISPLAY

Pre-alarms  
Alarms  
Engine measures  
Alternator measures  
Operating mode  
Genset status  
Genset contactor status  
Glow plugs status

##### CONTROL MODULE FUNCTIONS

Remote Start and Stop  
Manual Start and stop  
Emergency stop button on panel board  
Remote emergency stop  
Remote test on load  
Scheduled start-ups  
MODBUS commands (Start, Stop, Reset, Test)

Elcos MC2 control module is designed for diesel generating sets. It offers outstanding protection, monitoring and control for small and middle size generator sets.

AAABBB

## OPTIONAL

### Fuel Supply



**O.G-ACO-AT-C3V-01**

External fuel tank connections with 3-way valve for supply from internal or external tank (10/100 kVA)



**O.G-ACO-AT-C3V-AR-01**

Quick coupling connectors with 3-way valve for internal or external fuel tank connection (10/100 kVA)



**O.G-ACO-AT-CI-01**

External tank connections for supply only from external tank (g without tank) GE 10/100



**O.G-ACO-BT-C1750-600**

600 Lt Oversized Fuel Tank on board for SS,RB (10/20 kVA)



**O.G-ACO-GA-01**

Mechanical analogue float for internal fuel tank on board



**O.G-ACO-GA-02**

Electrical analogue float to monitor the external refilling point on board



**O.G-ACO-RE-01**

External refilling point for Gen Sets 10/250 kVA, SS, RB versions



**O.G-ACO-RE-SP-01**

External refilling point with warning light for Gen Sets 10/250 kVA, SS, RB versions

### Alternator

**O.G-ALT-AL-CHBR-01**

Different brand alternator (10/40 kVA)

### Batteries



**O.G-BAT-BAE-01**

Maintenance free high efficiency starter batteries (10/40 kVA)



**O.G-BAT-STB-01**

Battery isolator lockable (10/100 kVA)

### Canopy



**O.G-COF-AM-01**

Hinges and Doors with tamper-proof device (10/100 kVA)



**O.G-COF-AP-01**

Door opening alarm system (each door)









**O.G-COF-C1750-INOX**

Additional cost for stainless steel canopy (C1750)























**O.G-COF-CA-C1750**

IP 43 Conveyors for Gen Sets 10/20 kVA - supplied disassembled

	<b>O.G-COF-CH-01</b>	Additional cost for larger canopy C1900 instead of standard C1750 - Dim. cm 190x90x150H - Fuel tank 110 lt
	<b>O.G-COF-DLO-C1750-03KW</b>	Dummy Load 3kW on board for Gen Sets 15 kVA
	<b>O.G-COF-EAF-01</b>	Frontal air expulsion for Gen Sets 10/20 kVA (C1750) (change the noise level)
	<b>O.G-COF-FP-01</b>	Door stop (10/100 kVA)
	<b>O.G-COF-IL-01</b>	Internal LED lighting with micro-switches for Gen Sets 10/250 kVA
	<b>O.G-COF-PV-01</b>	Lift off doors kit (10/100 kVA) for SS and PRO version
	<b>O.G-COF-TRT-MAR-01</b>	High resistance canopy treatment for corrosive environments for 10/40 kVA (SS, RB Versions)
	<b>O.G-COF-VER-PAR-01</b>	Canopy custom paint (Grey base-frame) for 10/40 kVA (SS, RB Versions)
	<b>O.G-COF-VER-TOT-01</b>	Total canopy custom paint for 10/40 kVA (SS, RB Versions)

### ⚙️ Electrical on board

	<b>O.G-USP-MO-01</b>	Terminal box with tightening terminals inside the cable entry compartment for Gen Sets 10/40 kVA SS Version
	<b>O.G-USP-SW-MOT.0010-0040</b>	Motorization switch on board machine, integrated in the panel for 10/40 Kva Ge - (for variant +11)
	<b>O.Q-QBM-BMIN-230V-01</b>	Additional price for 230V minimum voltage coil on the modular main switch inside the control panel (check feasibility)
	<b>O.Q-QBM-CPI-BEN-01</b>	Permanent insulation controller for IT networks up to 230V / 400V. BENDER IR423-D4-1. Adjustable threshold 10 ÷ 300 kohm. (2 DIN rail modules - check feasibility)
	<b>O.Q-QLE-K-DIF-M3</b>	Adjustable differential protection only for MC2-PLUS controller for Gen Sets 10/500 kVA (+011 variant)
	<b>O.Q-QLE-QBM-COM-AMF25</b>	Additional price for QBM COMAP AMF25 panel replacing the standard QLE-A.
	<b>O.Q-QLE-QBM-DSE-7320</b>	Additional price for QBM DSE7320 panel replacing the standard QLE-A.
	<b>O.Q-QLE-QPE-MC4</b>	Additional price for QPE-C panel with MC4 replacing the standard QLE-A.

	<b>O.Q-QMC-K-DIF-R1</b>	Adjustable differential protection only for QMC panel for Gen Sets 10/40 kVA (Variant +010 / +011)
	<b>O.Q-QMC-RX8-QMC</b>	Start-stop radio control with max. radius 500 mt indoors and 5 km outdoors (for QMC panel).
	<b>O.Q-QMC-SAS-01</b>	Auto Start-Stop at load request (QMC panel)
	<b>O.Q-QPE-INT-CST-01</b>	GE main switch STATUS contact wired to terminal board inside the QPE panel on board generator (10 / 40KVA) (no variant +10)
	<b>O.Q-QPE-SAS-02</b>	Auto Start-Stop at load request (QPE, QLE panels)
<b>Engine</b>		
	<b>O.G-MOT-FC-1</b>	Dust collector filter - for Gen Sets 10/20 kVA
	<b>O.G-MOT-FSA-1</b>	Fuel/Water Separator Filter - for Gen Sets 10/20 kVA
	<b>O.G-MOT-K-40C-01</b>	Engine liquids suitable for -40°C ambient temperature for Gen Sets 10/40 kVA
	<b>O.G-MOT-PO-01</b>	Oil change pump for Gen Sets 10/100 kVA
	<b>O.G-MOT-RF-01</b>	Electronic speed governor for Gen Sets 10/40 kVA
	<b>O.G-MOT-SC-AC-EL-01</b>	Engine pre-heater 230V with thermostat on board for Gen Sets 10/100 kVA + 130/500 PRO version
	<b>O.G-MOT-SC-AC-EL-02</b>	Super hot engine heater 230V with thermostat on board for Gen Sets 10/100 kVA
	<b>O.G-MOT-SE-PO-LR</b>	Oil pressure level and engine temperature sensors (from 10 to 100kVA)
	<b>O.G-MOT-SRO-AU-12L</b>	Automatic oil refilling system (10/40 kVA)
<b>Handling</b>		
	<b>O.G-MOV-CN-3</b>	Off-road trailer with 2 pneumatic wheels and tow bar (SS, RB Gen Sets 10/40 kVA)
	<b>O.G-MOV-CO-ST-02</b>	Roadworthy trailer 80km/h (10/40 kVA), registration excluded.



**O.G-MOV-GC-BIG-01**

Increased central lifting hook with 10x5cm hole (10/250 kVA SS version)

**O.G-MOV-KRM-SS-01**

 Reinforcement kit for mobile installation (dedicated trailers or wheeled machinery) SS  
Version from 10 to 40 kVA

 **ATS Panels**

**QC1.0060A**

Separate ATS panel, 4P - 60A contactors (40 kVA 400V - 30 kVA 230V) Dim. 60 x 25 x 80 cm - 47 kg. (ex QC1.040)

**QLTS.060A**

Wall-mounted ATS switching panel 60A 4P (40 kVA 400V - 20 kVA 230V) Dim. 40 x 16 x 40 cm - 12 kg.

 **Exhaust**

**O.G-SCA-CAT-01**

Catalytic converter (10/15 kVA)

**O.G-SCA-FAP-K20**

Particulate filter (DPF) for Gen Sets 10/20 kVA

**O.G-SCA-GF-50**

Exhaust bellow with flexible joint including flange and counter flange (10/40 kVA)

**O.G-SCA-KS-50**

Exhaust flex pipe for drainage (length 3 mt.)

**O.G-SCA-PF-01**

Spark arrester for Gen Sets 10/40 kVA

**O.G-SCA-PR-01**

Exhaust pipe protection kit (10/20 kVA) , SS,RB version

 **Test**

**MS.CP-LT-01**

FAT - Factory Acceptance Test for single Gen Set from 10 to 100 kVA according to our standard procedures in Elcos factory (max 2 hours - max 4 people - max 1 hour of operation)

**MS.CP-SP-01**

FAT - Factory Acceptance Test for single custom Gen Set from 10 to 100 kVA max 4 operating hours or parallel system up to 4 units for 1 operating hour, in Elcos factory (max 4 hours - max 4 people )

**MS.CP-ST-01**

FAT - Factory Acceptance Test for single Gen Set from 10 to 100 kVA according to our standard procedures in Elcos factory (max 4 hours - max 4 people - max 2 hour of operation)

**MS.RF-ST-01**

Noise test report for single Gen Set from 10 to 250 kVA

**MS.TV-ST-01**

Vibration test on 10 points with certificate for single Gen Set from 10 to 250 kVA

 **Vari**

**O.G-VAR-CAT-01**

Toolbox for ordinary maintenance.

**O.G-VAR-PUN-TER-01**

Round earth spike, diam. 20 mm, height 1.5mt, galvanized, complete with clamp and 3m yellow/green cable model FS17 1x35mm<sup>2</sup> with cable lugs.

**O.G-VAR-PUN-TER-02**

Cross-shaped earth spike, height 1.5mt, galvanized, complete with clamp and 3m yellow/green cable model FS17 1x35mm<sup>2</sup> with cable lugs.

**O.G-VAR-TPD-01**

IP 55 document holder

## PRP

Engines of this rating provide unlimited hours of usage in a variable load application. The average load factor should not exceed 70% of the engine's prime power rating with a maximum number of 500 operational hours at 100% prime power rating. An overload capability of 10% is available, however, is limited to a period of 1 in every 12 hours

## LTP

Limited-time running power is defined as the maximum power available, under the agreed operating conditions, for which the generating set is capable of delivering for up to 500h of operation per year with the maintenance intervals. The overload is not allowed.

Sheet:	C 1750	SUPER SILENT	Exhaust side:	Type:	STANDARD	Rev:	00	Last Update:	May 03, 2012	Page 1/2
--------	--------	--------------	---------------	-------	----------	------	----	--------------	--------------	----------

**OVERALL DIMENSIONS [mm]**

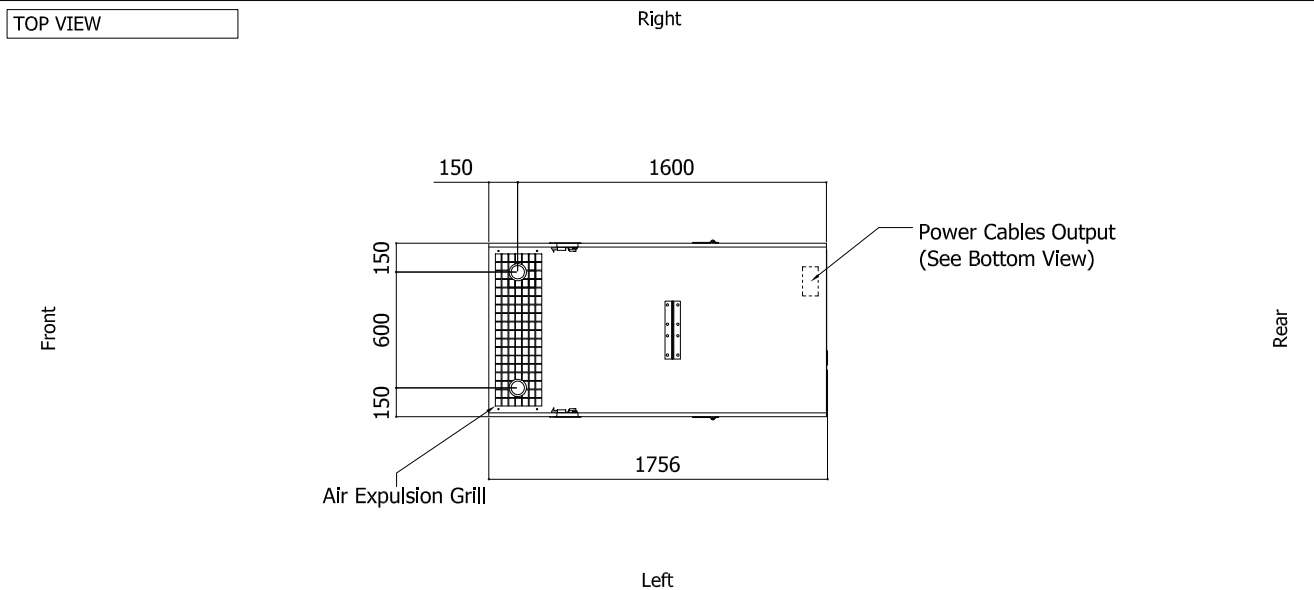
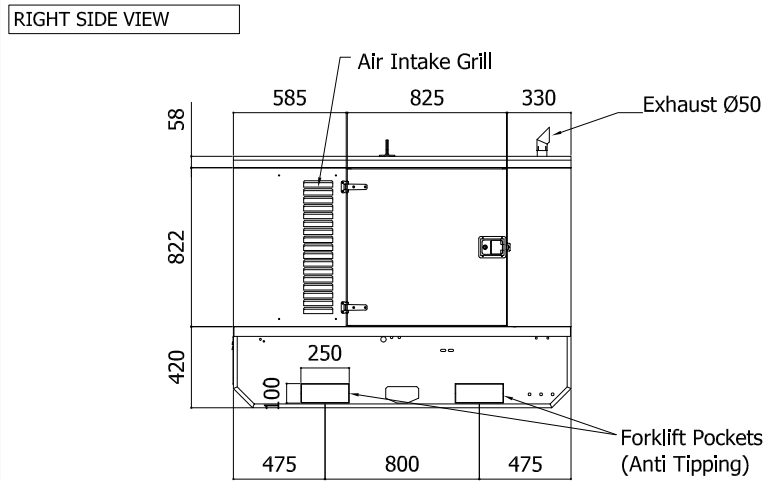
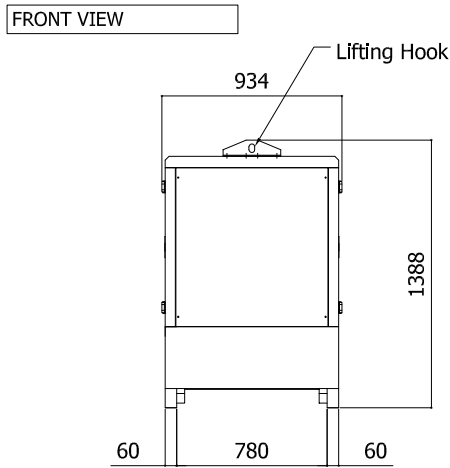
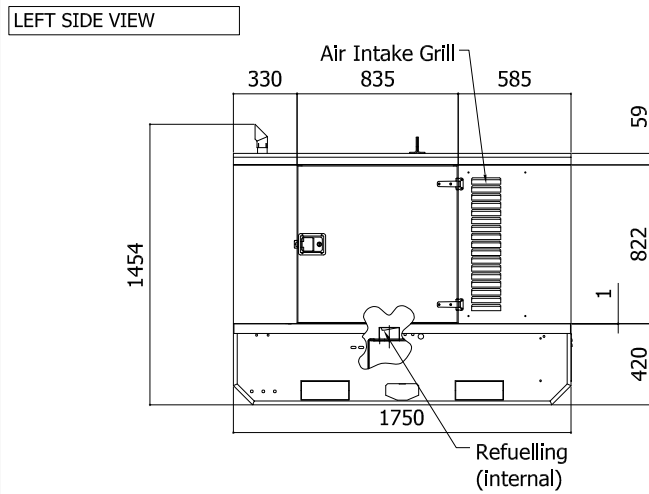
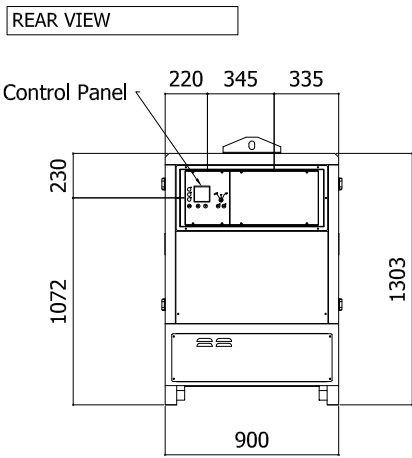

- IMPORTANT:**
- 1) Form and dimension refer to the generating set on catalogue
  - 2) Form and dimension are subject to change in order to update or improve the products
  - 3) This document can not be copied or transmitted without ELCOS S.r.l. approval

Sheet:	C 1750	SUPER SILENT	Exhaust side:		Type:	STANDARD	Rev:	00	Last Update:	May 03, 2012	Page 2/2
--------	--------	--------------	---------------	--	-------	----------	------	----	--------------	--------------	----------

**BOTTOM VIEW**

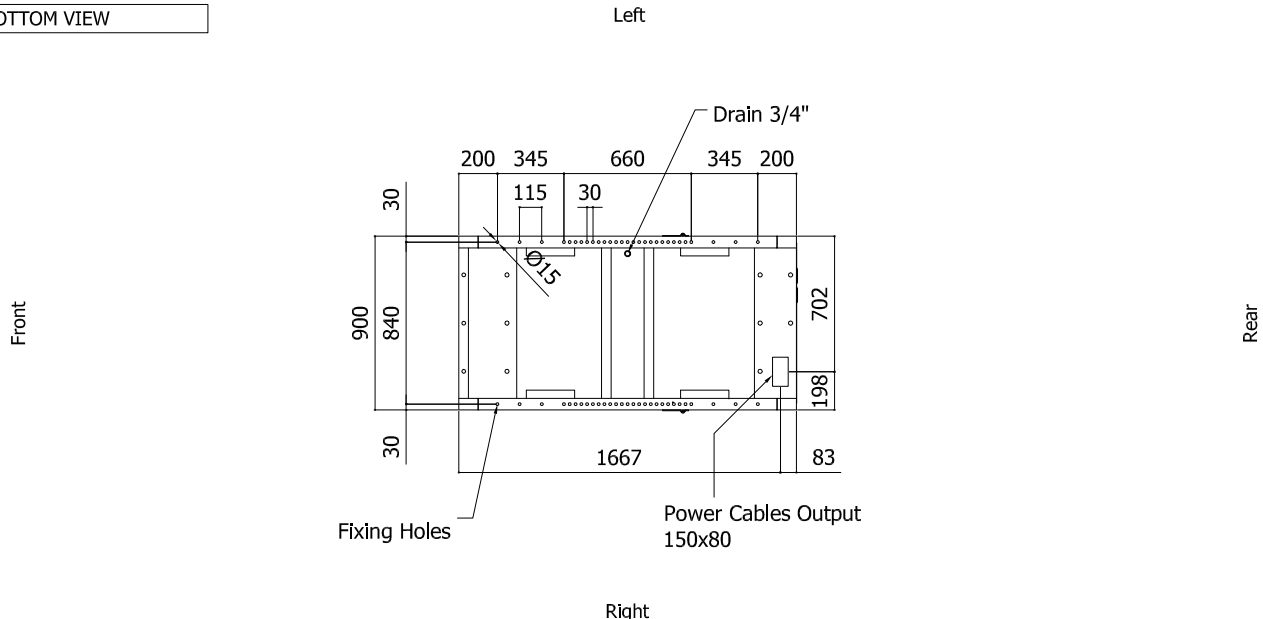

**DIMENSIONS WITH OPEN DOORS [mm]**

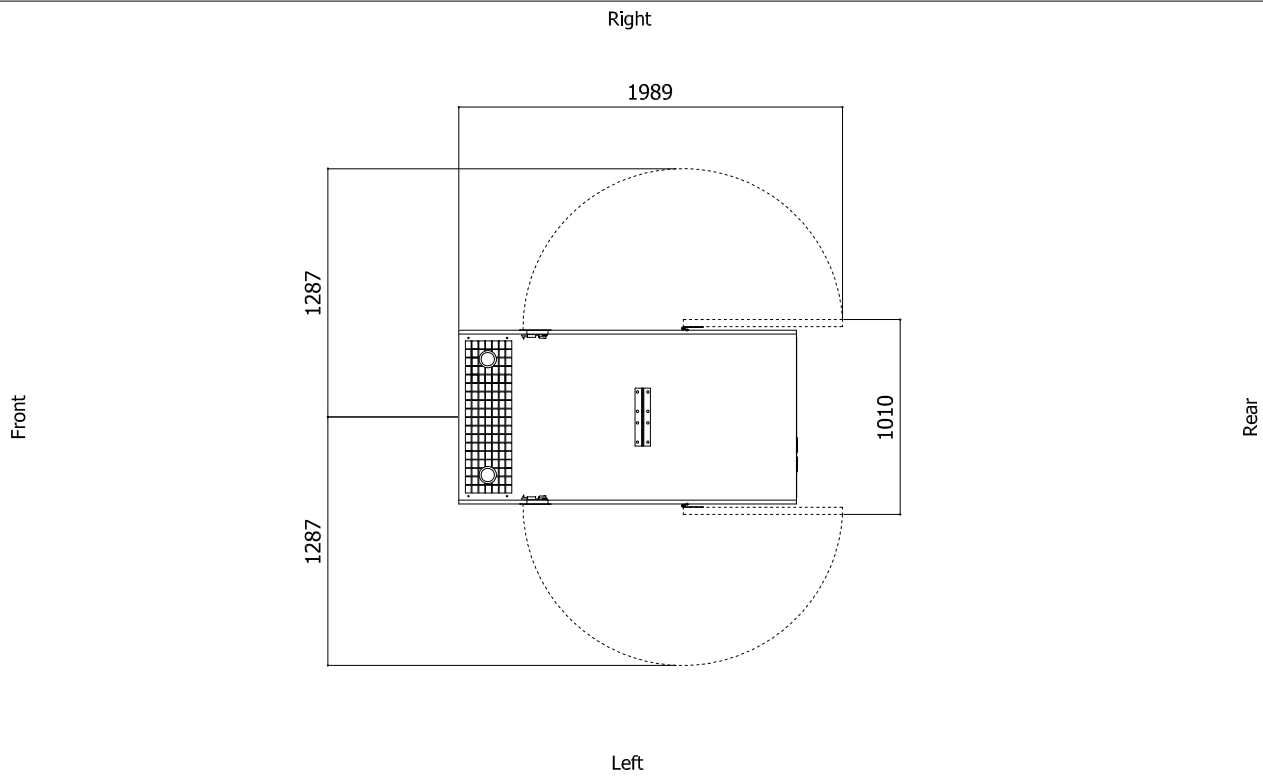

Note: With Lifting-Off Door Solution consider only canopy dimensions.  
(Models with "Control Panel" behind rear door will mount a special cover to protect it)

**VENTILATION OF THE ROOM**

The windows area in the generating set room needs to be (recommended):  
Aspiration: 0.26 m<sup>2</sup>  
Expulsion: 0.21m<sup>2</sup>  
ATTENTION: for a correct ventilation the expulsion air and the exhaust gas needs to be conveyed in the open-air

- IMPORTANT:**
- 1) Form and dimension refer to the generating set on catalogue
  - 2) Form and dimension are subject to change in order to update or improve the products
  - 3) This document can not be copied or trasmitted without ELCOS S.r.l. approval

Data and technical specifications are subject to change in order to update or improve the products.